

Glidewell HT™ IMPLANT SYSTEM

Guided Surgery Manual

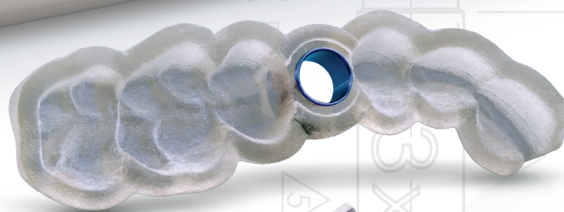

888-303-3975 | glidewell-ht.com

The Glidewell HT™ Implant System

The Glidewell HT™ Implant System, formerly known as the Hahn™ Tapered Implant System, is a premium implant solution that simplifies surgery and provides you with unrivaled support from the most experienced dental lab in the U.S. With a 99.2% success rate backed by an implant-to-crown lifetime warranty, the Glidewell HT Implant promotes success in implant dentistry while lowering your surgical and restorative costs.

- **Simple and efficient** — Easy to use, with a streamlined surgical protocol and length-specific drills
- **Cut your costs** — Priced at a fraction of comparable implant systems — and saves you 20% on your lab bill when you restore your implant case with Glidewell*
- **Clinically proven** — 99.2% success rate and 0.2 mm mean bone loss¹
- **High primary stability** — Deep, sharp threads maximize initial stability and engage bone where directed

“The **Glidewell HT Implant System** is engineered to help dentists provide implant treatment for more patients through **ease of use, reduced costs** and our **unwavering commitment to support your practice** — from implant placement to final restoration.”

Jim Glidewell, CDT

Founder and President of Glidewell



About the Manufacturer

Prismatik Dentalcraft was established in 2006 and includes a carefully assembled team of experts with a proven track record in the design, engineering, and manufacture of dental implants. Bolstered by a support staff of highly respected researchers, material scientists, clinical specialists, and dental technicians, Prismatik is dedicated to advancing implant therapies by combining proven treatment protocols with progressive materials, technologies, and techniques.



Vertical Integration

Our ownership of the entire manufacturing process behind our implant products ensures quality and helps reduce costs for our customers.

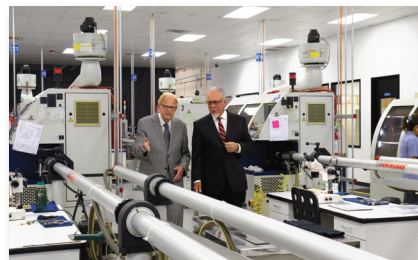

State-of-the-Art Equipment

Our Swiss-type lathes and CNC milling machines are ideal for implants and prosthetics requiring extreme precision.



Made in the USA

Our ISO-certified facility in Irvine, CA, operates under FDA Current Good Manufacturing Practices (CGMPs).

*Discount offered only at Glidewell and cannot be combined with any other special offers. Case must include an implant-level or multi-unit abutment-level impression with a Glidewell HT transfer coping or a digital scan with a Glidewell HT scan body. Impressions over cementable abutments are not eligible for discount.

1. Kerr M, Allen B, Park N. Clinical and radiographic evaluation of tapered implants with an aggressive reverse buttress thread and crestal microthreads: a retrospective study. For the full report, visit glidewell.com/ht-2-year.

5	Surgical Considerations	14	Surgical Protocol
	Scope		Surgical Plan and Guide Procurement
	Intended Use		Preoperative Procedures
	Contraindications		General Drilling Guidelines
	Compatibility		Drilling Sequence Chart
	Warnings		
6	Precautions	15	Soft Tissue Preparation
	MRI		Osteotomy Site Preparation
	Sterility	17	Implant Placement
7	Storage and Handling	19	Healing Component Placement
	Implant Selection		Closure and Suturing
		20	Second-Stage Uncovery (Two-Stage Surgical Protocol)
8	Instrumentation		
9	Guided Surgical Kit		
11	Tissue Punches	21	Guided Drilling Sequences
	Surgical Drills	22	Implant Packaging
13	Screw Taps	23	Policies and Warranty

Glidewell HT™ Implant is a trademark of Prismatic Dentalcraft, Inc.

Copyright © 2024, Prismatic Dentalcraft, Inc. Prismatic Dentalcraft, Inc. is not responsible for any damages or other liabilities (including attorney fees) resulting, or claimed to result in whole or in part, from actual or alleged problems arising out of the use of this information. The techniques, procedures and theories presented herein are provided in good faith and believed to be correct as of the date hereof. Any dental professional viewing this presentation must make his or her own decisions about the use of the materials and techniques for specific situations.

No representations as to the completeness or accuracy of this information is given, and no representations or warranties, either expressed or implied, of merchantability, fitness for a particular purpose or of any other nature are made here under with respect to the information or the product to which information refers.

SURGICAL CONSIDERATIONS

Scope

This manual outlines the appropriate procedures for guided placement of Glidewell HT™ Implants.

The procedures and guidelines presented herein are not adequate to allow inexperienced clinicians to administer professional implant treatment or prosthetic dentistry, and are not intended to substitute for formal clinical or laboratory training. Glidewell HT Implants should only be used by individuals with training and experience specific to their clinically accepted application. Prismahtik Dentalcraft, Inc. is not liable for damages resulting from treatment outside of its control. Responsibility rests with the provider.

CAUTION: U.S. federal law restricts this device to sale by, or on the order of, a licensed dentist or physician.

Intended Use

Glidewell HT Implants are designed for use in partially or fully edentulous patients to retain or support maxillary and mandibular single-unit, multiple-unit, and overdenture dental restorations in provisional or long-term applications. The implants are to be used for immediate loading only in the presence of adequate primary stability and appropriate occlusal loading.

Contraindications

Glidewell HT Implants should not be placed in patients discovered to be medically unfit for the intended treatment. Prior to clinical intervention, prospective patients must be thoroughly evaluated for all known risk factors and conditions related to oral surgical procedures and subsequent healing. Contraindications include but are not limited to:

- vascular conditions
- uncontrolled diabetes
- clotting disorders
- anticoagulant therapy
- metabolic bone disease
- chemotherapy or radiation therapy
- chronic periodontal inflammation
- insufficient soft tissue coverage
- metabolic or systemic disorders associated with wound and/or bone healing
- use of pharmaceuticals that inhibit or alter natural bone remodeling
- any disorders which inhibit a patient's ability to maintain adequate daily oral hygiene
- uncontrolled parafunctional habits
- insufficient height and/or width of bone, and insufficient interarch space

Treatment of children is not recommended until growth is finished and epiphyseal closure has occurred.

Compatibility

The Glidewell HT Implant Guided Surgery System may only be used in conjunction with Glidewell HT Implants. Use of third-party systems is not recommended and can lead to mechanical failure and/or unsatisfactory results.

Warnings

- Do not reuse Glidewell HT Implants. The reuse of such device on another patient is not recommended due to the risks of cross-contamination or infection.
- Glidewell HT Implants may only be used for their intended purpose in accordance with general rules for dental/surgical treatment, occupational safety, and accident prevention. They must only be used for dental procedures with the restorative components they were designed for. If the indications and intended use are not clearly specified, treatment should be suspended until these considerations have been clarified.

SURGICAL CONSIDERATIONS

- The following instructions are not sufficient to allow inexperienced clinicians to administer professional prosthetic dentistry. Glidewell HT Implants, surgical instruments, and prosthetic components must only be used by dentists and surgeons with training/experience with oral surgery, prosthetic and biomechanical requirements, as well as diagnosis and preoperative planning.
- The implant site should be inspected for adequate bone by radiographs, palpations and visual examination. Determine the location of nerves and other vital structures and their proximity to the implant site before any drilling to avoid potential injury, such as permanent numbness to the lower lip and chin.
- Absolute success cannot be guaranteed. Factors such as infection, disease, and inadequate bone quality and/or quantity can result in osseointegration failures following surgery or initial osseointegration.

Precautions

Surgical Procedures

Minimizing tissue damage is crucial to successful implant osseointegration. In particular, care should be taken to eliminate sources of infection, contaminants, surgical and thermal trauma. Risk of osseointegration failure increases as tissue trauma increases. For best results, please observe the following precautions:

- All drilling procedures should be performed at 2000 RPM or less under continual, copious irrigation.
- All surgical instruments used must be in good condition and should be used carefully to avoid damage to implants or other components.
- All instruments used for guided procedures should be inserted as far as possible through the guide sleeve.
- Implants should be placed with sufficient stability; however, excessive insertion torque may result in implant fracture, or fracture or necrosis of the implant site. The proper surgical protocol should be strictly adhered to.
- Since implant components and their instruments are very small, precautions should be taken to ensure that they are not swallowed or aspirated by the patient.
- Prior to surgery, ensure that the needed components, instruments and ancillary materials are complete, functional and available in the correct quantities.

Prosthetic Procedures

Following successful placement of Glidewell HT Implants, verify primary stability and appropriate occlusal loading before proceeding with the placement of a permanent or provisional prosthesis. All components that are used intraorally should be secured to prevent aspiration or swallowing. Distribution of stress is an important consideration. Care should be taken to avoid excessive loads significantly transverse to the implant axes.

MRI

The Glidewell HT Implant System has not been evaluated for safety and compatibility in the magnetic resonance (MR) environment. It has not been tested for heating, migration, or image artifact in the MR environment. The safety of the Glidewell HT Implant System in the MR environment is unknown. Scanning a patient who has the device may result in patient injury.

Sterility

Glidewell HT Implants are shipped sterile. They should not be resterilized. They are for single use only, prior to the expiration date. Do not use implants if the packaging has been compromised or previously opened.



SURGICAL CONSIDERATIONS























Storage and Handling

Glidewell HT Implants must be stored in a dry location at room temperature, in their original packaging. Glidewell HT Implants are packaged sterile. Do not handle implant surfaces directly. Users are advised to visually inspect packaging to ensure seals and contents are intact prior to use. Please refer to the individual product label for all relevant product information and cautions.

Implant Selection

The Glidewell HT Implant Guided Surgery System is designed for the guided placement of Glidewell HT Implants in four diameters (3.0 mm, 3.5 mm, 4.3 mm, 5.0 mm) and five lengths (8 mm, 10 mm, 11.5 mm, 13 mm, 16 mm). The narrowest implants (3.0 mm) are intended for anterior applications only, and therefore limited to longer lengths. All 3.5 mm and 4.3 mm diameter Glidewell HT Implants share the same prosthetic platform.

The Glidewell HT Implant Guided Surgery System utilizes color-coding for easy component identification. Color-coding is featured consistently across system articles such as surgical tray, surgical drills, and the implant carrier, with colors reflecting either the implant diameter or restorative platform, as indicated in the legend below:

Ø3.0 mm	Ø3.5 mm	Ø4.3 mm	Ø5.0 mm
			
	 Ø3.5 x 8 mm 70-1189-IMP0004	 Ø4.3 x 8 mm 70-1189-IMP0009	 Ø5.0 x 8 mm 70-1189-IMP0014
	 Ø3.5 x 10 mm 70-1189-IMP0005	 Ø4.3 x 10 mm 70-1189-IMP0010	 Ø5.0 x 10 mm 70-1189-IMP0015
 Ø3.0 x 11.5 mm 70-1189-IMP0001	 Ø3.5 x 11.5 mm 70-1189-IMP0006	 Ø4.3 x 11.5 mm 70-1189-IMP0011	 Ø5.0 x 11.5 mm 70-1189-IMP0016
 Ø3.0 x 13 mm 70-1189-IMP0002	 Ø3.5 x 13 mm 70-1189-IMP0007	 Ø4.3 x 13 mm 70-1189-IMP0012	 Ø5.0 x 13 mm 70-1189-IMP0017
 Ø3.0 x 16 mm 70-1189-IMP0003	 Ø3.5 x 16 mm 70-1189-IMP0008	 Ø4.3 x 16 mm 70-1189-IMP0013	 Ø5.0 x 16 mm 70-1189-IMP0018

All instrumentation is manufactured in the U.S.A. or Switzerland. For specific country of origin, please refer to the individual product label. Instruments may be used for up to five preparations. For best results, replace regularly.

Surgical instruments are shipped non-sterile. Surgical tray and instruments must be cleaned, disinfected, and sterilized according to a validated method.

- **Cleaning:** Wash using a broad spectrum cleaning solution, followed by thorough rinsing and drying.

The recommended disinfection process is based on ANSI/AAMI ST79 guidelines, as follows:

- **Disinfection:** Immerse in disinfectant,¹ rinse with distilled water and dry.

The recommended sterilization process is based on the ANSI/AAMI/ISO 17665-1 and ANSI/AAMI ST79 guidelines, as follows:

- **Sterilization:** Gravity-fed sterilizers: Autoclave in sterilization pouch for 15 minutes at 132°C (270°F). Allow sterilized components to dry for at least 30 minutes.

 **NOTE:** The validated procedures require the use of FDA-cleared sterilization trays, wraps, biological indicators, chemical indicators, and other sterilization accessories labeled for the sterilization cycle recommended. The healthcare facility should monitor the sterilizer for the facility according to an FDA-recognized sterility assurance standard such as ANSI/AAMI ST79.

¹Oral disinfectant containing *Chlorhexidine* is recommended; refer to the disinfectant manufacturer's instructions.



Guided Surgical Kit

The guided surgical kit allows the clinician to easily organize, store, and transport the instrumentation components of the Glidewell HT Implant Guided Surgery System. Drills are arranged from left to right in order of increasing diameter, following the recommended drilling sequence. Color-coded fields indicate the corresponding diameter of the Glidewell HT Implant.

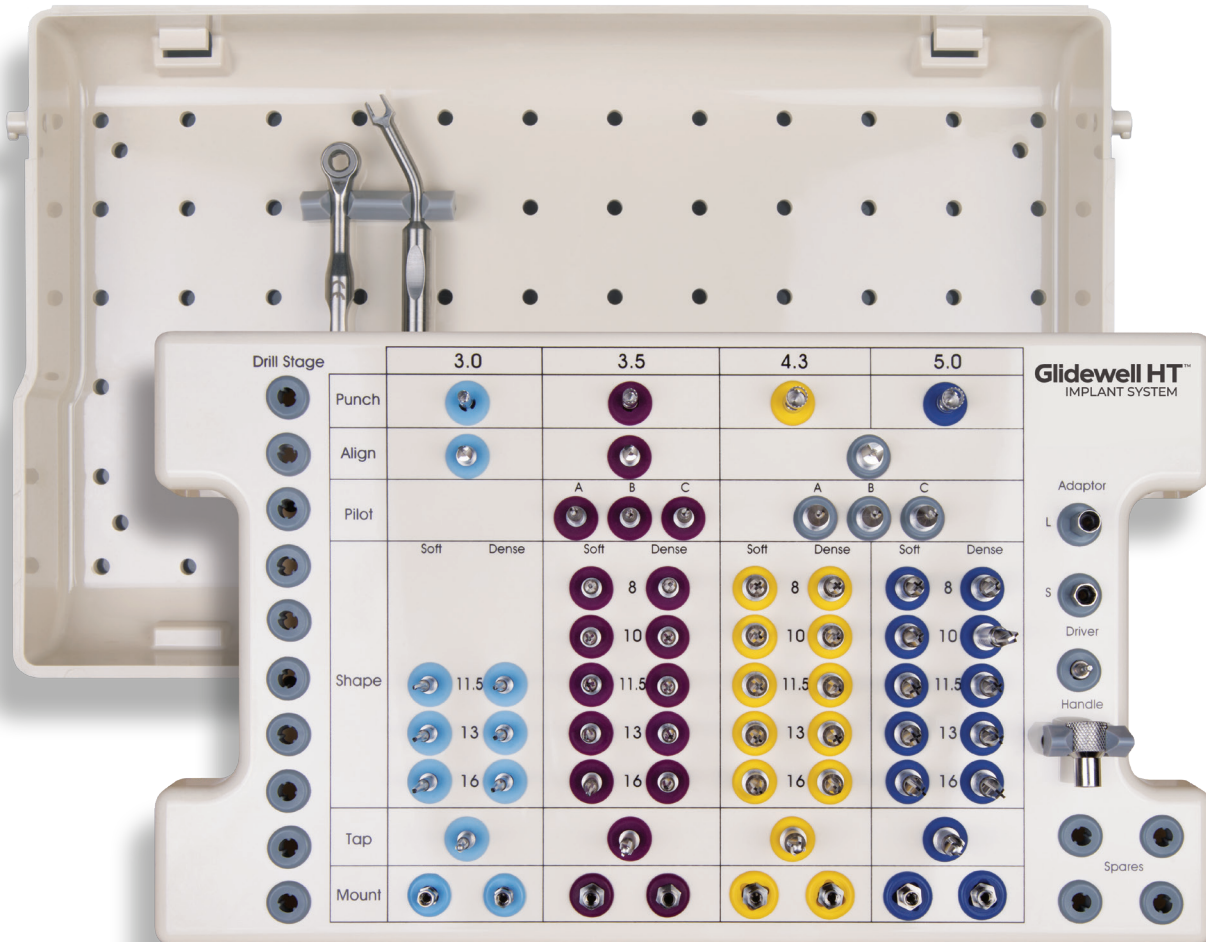

⚠ NOTE: For a detailed product listing, please refer to the *Glidewell HT Implant System Product Catalog*, or contact a Glidewell Direct sales representative at 888-303-3975.



Tissue Punches

Tissue Punches are designed for atraumatic excision of soft tissue at the surgical site. They are available in four diameters (3.0 mm, 3.5 mm, 4.3 mm, 5.0 mm) to match the diameter of the prescribed implant.

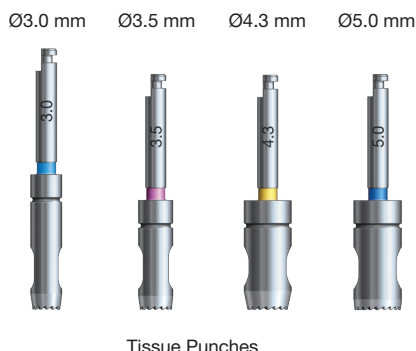

Surgical Drills

The Glidewell HT Implant Guided Surgery System features a full range of surgical drills, including three diameters of Alignment Drills (3.0 mm, 3.5 mm, 4.3/5.0 mm), two diameters of Pilot Drills (3.5 mm, 4.3/5.0 mm), and four diameters of Shaping Drills and Dense Bone Shaping Drills (3.0 mm, 3.5 mm, 4.3 mm, 5.0 mm). All feature a flange stop for depth control and are designed to achieve maximum cutting efficiency while effectively removing bone from the osteotomy.

Alignment Drills are used to perforate the alveolar crest and establish proper concentric alignment for the drills that follow.

Pilot Drills are stepped to accommodate the tapered design of the implant. Three lengths are available: A (8 mm), B (10 mm), C (13 mm). Drill length is calculated to indicate where the top of the implant will reside when fully seated to that depth.

All **Shaping Drills** are both diameter- and length-specific, to match the size of the prescribed implant. In the presence of dense bone, **Dense Bone Shaping Drills** may be used to prepare the osteotomy.

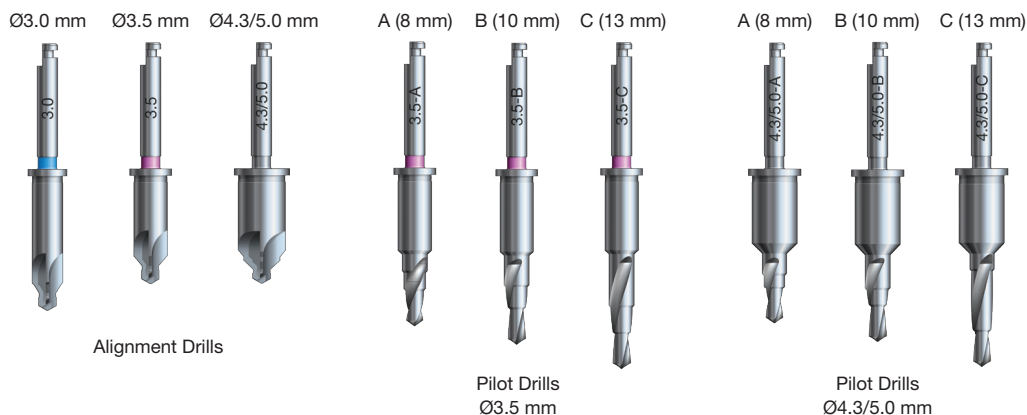



Shaping Drills

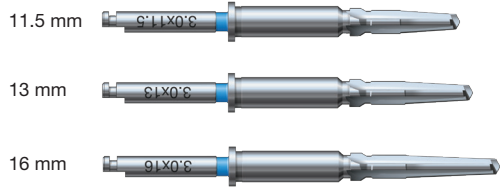

Shaping Drills Ø3.0 mm

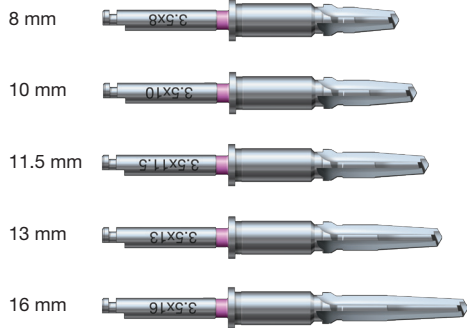

Shaping Drills Ø3.5 mm

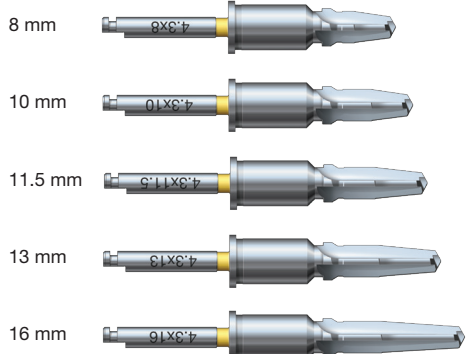

Shaping Drills Ø4.3 mm

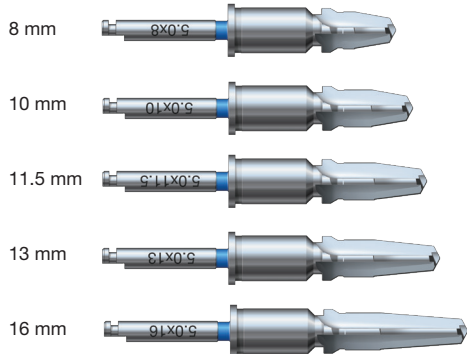

Shaping Drills Ø5.0 mm

Dense Bone Shaping Drills *(Optional for Dense Bone)*

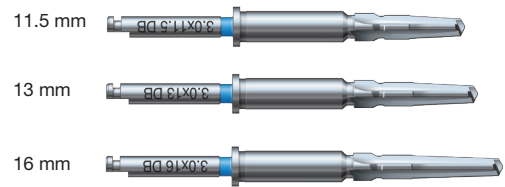

Dense Bone Shaping Drills Ø3.0 mm

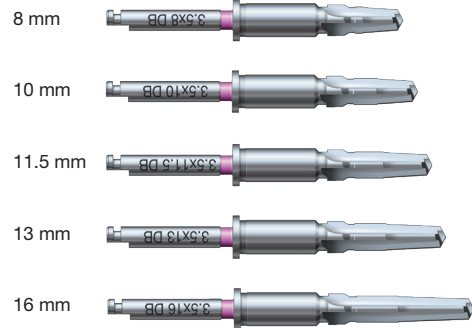

Dense Bone Shaping Drills Ø3.5 mm

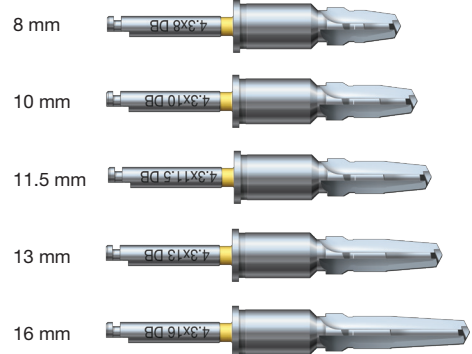

Dense Bone Shaping Drills Ø4.3 mm

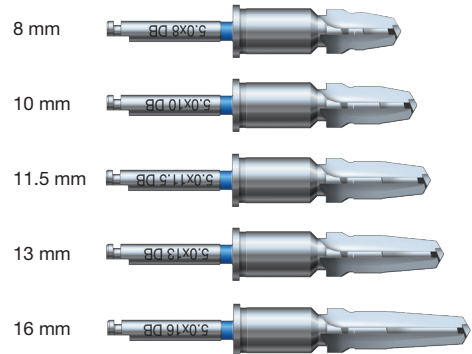

Dense Bone Shaping Drills Ø5.0 mm

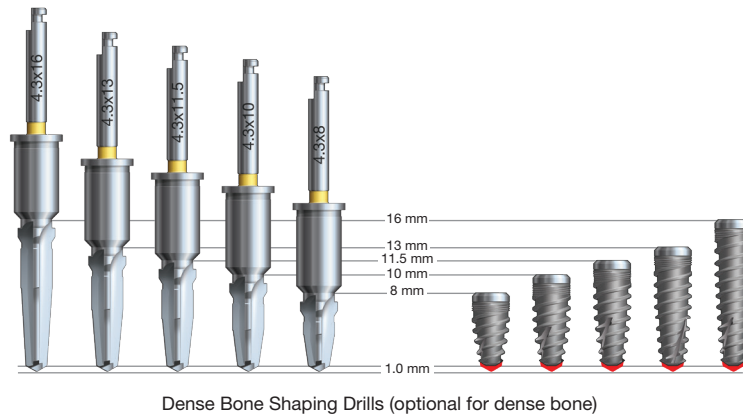
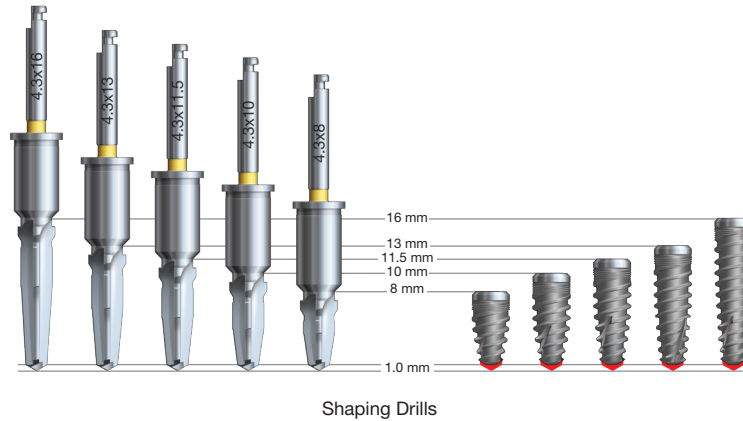

! **NOTE:** Due to the cutting tip, the osteotomy preparation typically extends 1 mm longer than the stated length of the implant. This added length must be taken into account when planning the case.

Screw Taps (Optional for Dense Bone)

For the placement of Glidewell HT Implants in extremely dense bone, it may be necessary to utilize a thread-forming screw tap corresponding to the diameter of the implant body. Due to the tap design and implant cutting efficiency, one tap is used for multiple implant lengths. The coronal head of each screw tap is slightly flared, resulting in a gentle expansion of the cortical plate for receiving the wider neck of the implant.

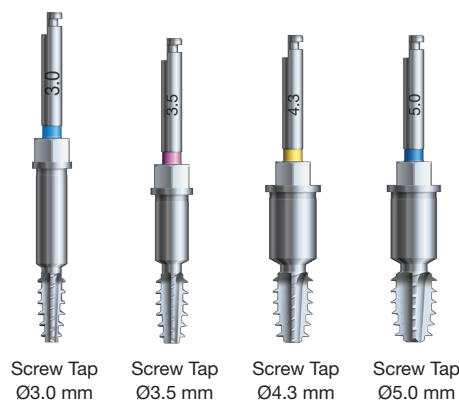

■ Surgical Plan and Guide Procurement

To support an open workflow, the Glidewell HT Implant Guided Surgery System is compatible with a variety of digital treatment planning software programs and surgical guide manufacturers. For detailed workflow and ordering information, please contact the software company or guide manufacturer of your choice, or contact Glidewell at 866-497-3692.

■ Preoperative Procedures



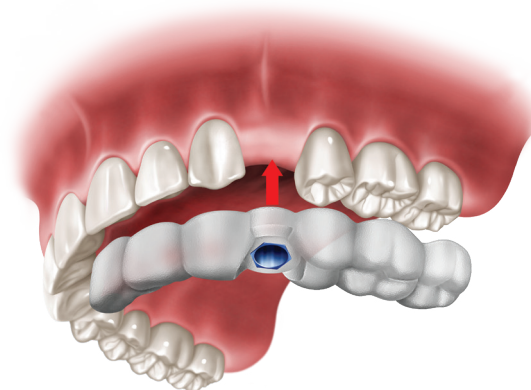

- Thoroughly review the surgical plan, ensuring that the position of each sleeve in the guide corresponds with the surgical plan.
- Disinfect or sterilize the surgical guide using an appropriate liquid chemical disinfectant or liquid sterilizing agent.
- Try in the surgical guide to confirm stability and fit.
- Ensure that the guide sleeves are not touching the soft tissue.

■ General Drilling Guidelines

- All instruments used for guided procedures should be inserted as far as possible through the guide sleeve.
- Motor speed should be 30–100 RPM when using any of the Tissue Punches.
- A speed of 800–1200 RPM is recommended when using the Alignment Drills, Pilot Drills, or Shaping Drills.
- Screw Tap speed should be no greater than 25 RPM.
- All drilling and tapping procedures should be performed using copious, sterile irrigation.
- Do not apply lateral pressure during drilling and tapping procedures.
- Drill the osteotomy using light pressure along the long axis of the osteotomy.



Drilling Sequence Chart

	Tissue Punch	Alignment Drill	Pilot Drill*	Shaping Drill*	Dense Bone Shaping Drill*	Screw Tap
 Ø3.0 mm	Ø3.0	Ø3.0		Ø3.0	Ø3.0	Ø3.0
 Ø3.5 mm	Ø3.5	Ø3.5	Ø3.5	Ø3.5	Ø3.5	Ø3.5
 Ø4.3 mm	Ø4.3	Ø4.3/5.0	Ø4.3/5.0	Ø4.3	Ø4.3	Ø4.3
 Ø5.0 mm	Ø5.0	Ø4.3/5.0	Ø4.3/5.0	Ø5.0	Ø5.0	Ø5.0

Final Drill
 Optional – Dense Bone
 *Available in various lengths.

■ Soft Tissue Preparation

Option 1: Tissue Excision

Following administration of anesthesia, seat the surgical guide. If applicable, secure the guide in place, using anchor pins as needed. Select the Tissue Punch with a diameter matching that of the prescribed implant. With copious irrigation, drill until the Tissue Punch meets the bone. Remove the circular patch of soft tissue.

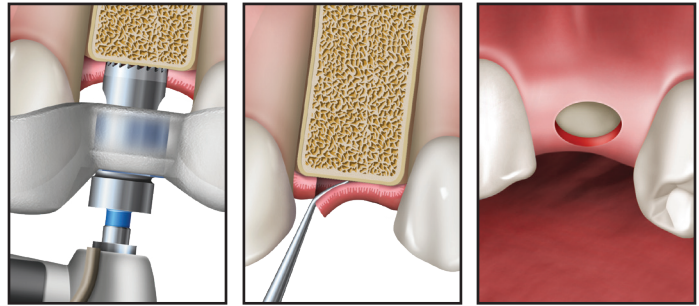

Option 2: Tissue Reflection

Following administration of anesthesia, make an incision designed for elevation of a flap. Seat the surgical guide; secure the guide in place with anchor pins, if applicable.

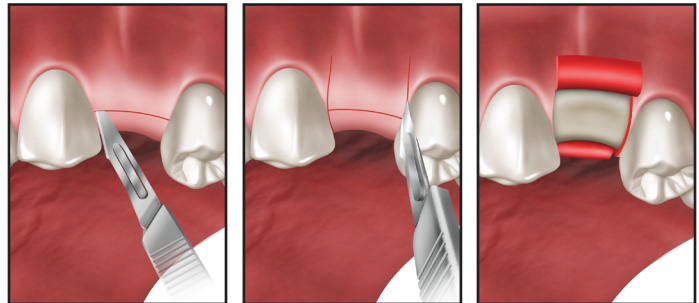

■ Osteotomy Site Preparation

Step 1: Alignment Drill

Select the Alignment Drill with a diameter matching that of the implant. With copious irrigation, perforate the alveolar crest.



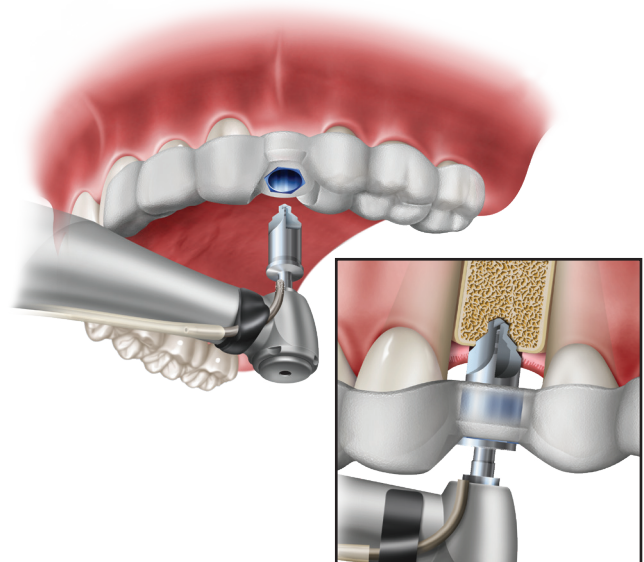

! NOTE: If placing a Glidewell HT Implant that is 3.0 mm in diameter, proceed to Step 3: Shaping Drill.



SURGICAL PROTOCOL

Step 2: Pilot Drill (for Ø3.5 mm – Ø5.0 mm Implants)

If placing a Glidewell HT Implant that is 3.5 mm in diameter or greater, Pilot Drills are used to deepen the osteotomy. Each Pilot Drill is labeled according to the diameter of implant for which it is intended to be used. Pilot Drills are available in three lengths: A (8 mm), B (10 mm), C (13 mm). Select the appropriate Pilot Drill, accounting for the size of the implant to be placed, taking care not to exceed the length of the implant. If placing an implant that is 8 mm in length, Pilot Drill A should be used. If placing an implant that is 10 mm or 11.5 mm in length, Pilot Drill B should be used. If placing an implant that is 13 mm or 16 mm in length, Pilot Drill C should be used. With copious irrigation, drill a pilot hole to depth.

	Pilot Drill	Implant Length
	A	8 mm
	B	10 mm and 11.5 mm
	C	13 mm and 16 mm

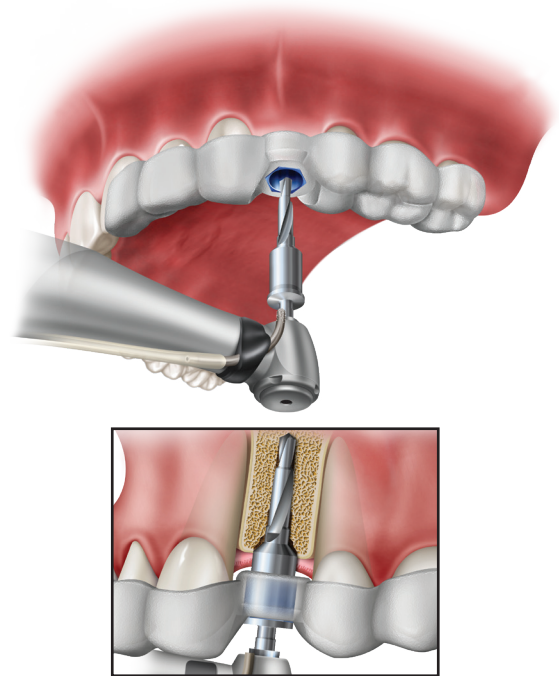

Pilot Drills Ø4.3/5.0 mm



Step 3: Shaping Drill

Each Shaping Drill is both diameter- and length-specific, to match the size of the prescribed implant.

Select the appropriate Shaping Drill, taking care not to exceed the length of the implant. With copious irrigation, drill to depth. The drill should correspond with the matching implant size, with the goal of achieving high primary stability upon implant placement.

	Shaping Drills Ø5.0 mm
	Dense Bone Shaping Drills Ø5.0 mm

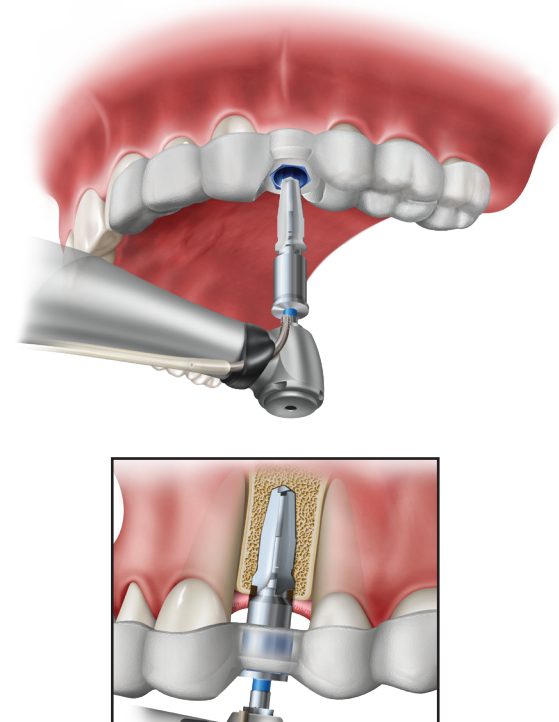

Step 4: (Optional) Dense Bone Shaping Drill

If indicated by the presence of dense bone, select the Dense Bone Shaping Drill with a diameter and length matching that of the prescribed implant. With copious irrigation, drill to depth.

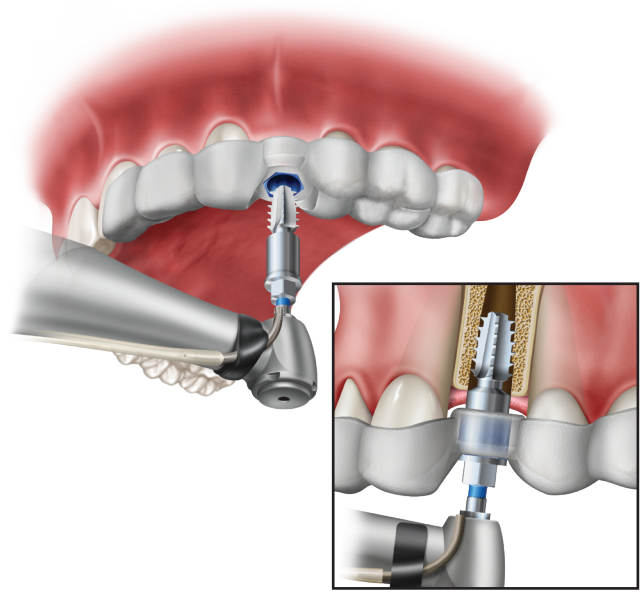

Step 5: (Optional) Screw Tap

If indicated by the presence of dense bone, select the Screw Tap with a diameter matching that of the implant. Place the tap into the prepared implant site. Apply firm pressure and begin slowly rotating the tap (25 RPM maximum). When the threads begin engaging the bone, allow the tap to feed into the site without applying additional pressure. The osteotomy should be tapped through the cortical bone. Reverse the tap out of the site.

⚠ NOTE: Do not rotate the tap after the flange makes contact with the guide sleeve, as this might damage the threads prepared in the bone and result in less than optimal primary stability.

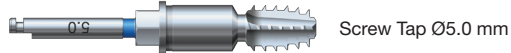

■ Implant Placement

Step 1: Implant Selection

Remove the titanium implant holder from its packaging and place it onto a sterile field.

⚠ NOTE: The plastic tray contains a Cover Screw, for use when following a two-stage surgical protocol. Do not discard the Cover Screw upon removal of the implant.

Engage the implant connection with the appropriate Implant Mount. Fasten the assembly using the screw captured in the Implant Mount. With the implant securely attached to the mount, squeeze the opposing end of the holder to disengage the implant from the holder.

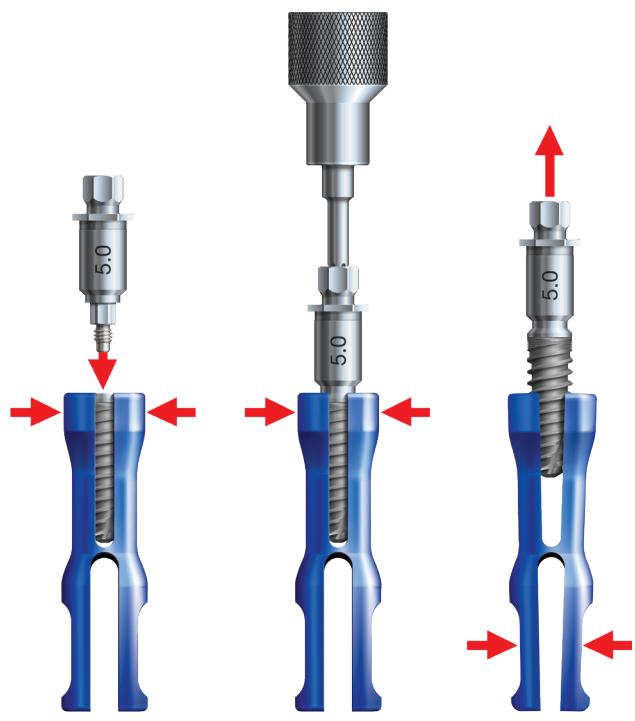

SURGICAL PROTOCOL

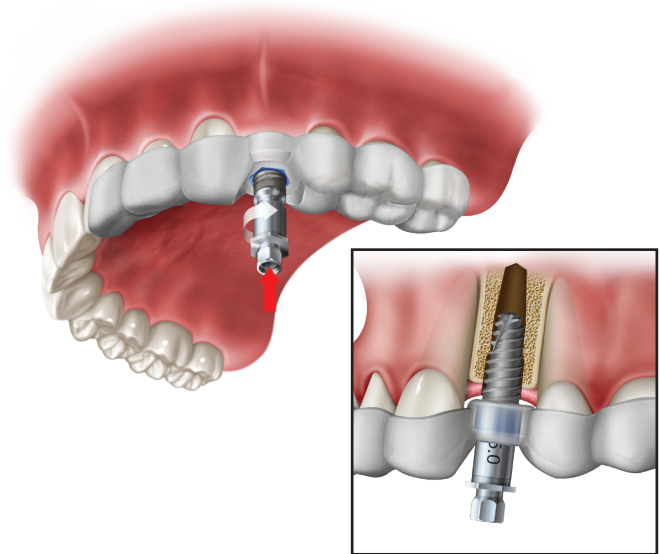
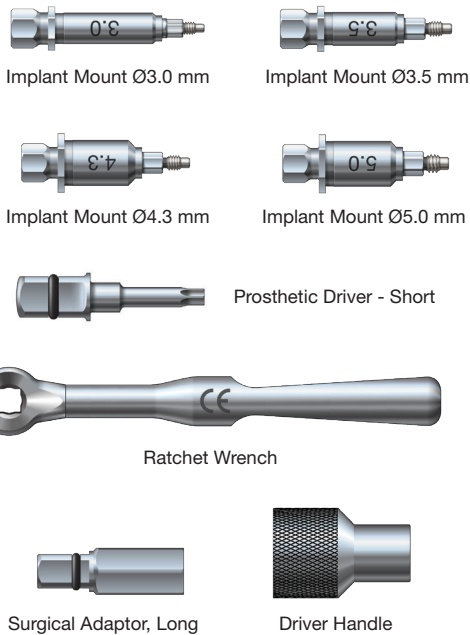

Step 2: Initial Placement

Transport the implant to the prepared site, then insert it through the guide and into the osteotomy. Rotate clockwise with applied pressure to engage the self-tapping grooves.

Step 3: Advancement and Final Seating

Assemble the Ratchet Wrench with the Surgical Adaptor. With the implant secured to the Implant Mount, seat the adaptor atop the mount and engage the connection. Turn the wrench clockwise in increments of approximately 90 degrees. Continue threading the implant into the osteotomy site until the hex flange on the Implant Mount meets the hex of the guide sleeve. Adjust the final position of the implant by aligning the hex on the Implant Mount with the hex of the guide sleeve. This will allow the restoring clinician to take full advantage of the anatomical abutment contours and minimize the need for abutment preparation. A minimum torque value of 35 Ncm upon final seating indicates good primary stability.

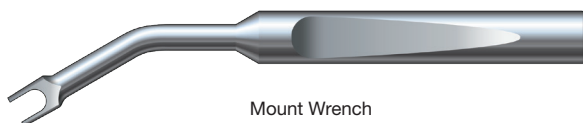
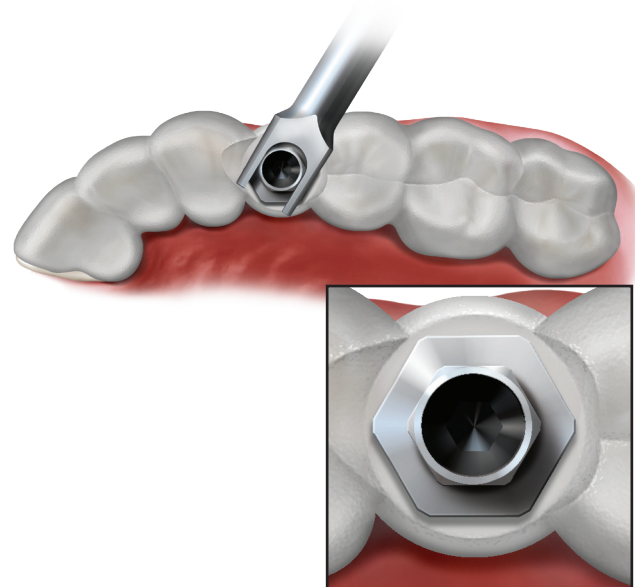
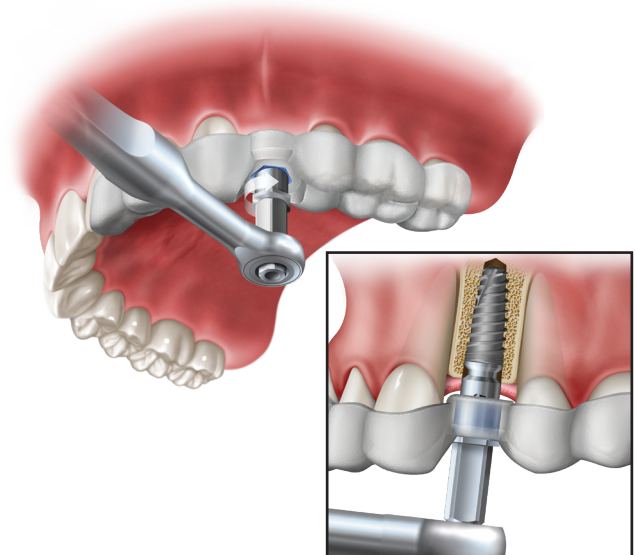



⚠ NOTE: The Mount Wrench may be used to make fine adjustments. Do not rotate after the flange on the Implant Mount fully meets the guide sleeve and the corresponding hexes are aligned. Doing so may cause the osteotomy to strip.

Following implant placement, ensure that the flats of the Implant Mount and guide sleeve are aligned. Remove the Implant Mount by unscrewing it from the implant. Then remove the surgical guide. Prepare the site for healing by placing either a Healing Abutment (single-stage surgical protocol) or the Cover Screw (two-stage surgical protocol).

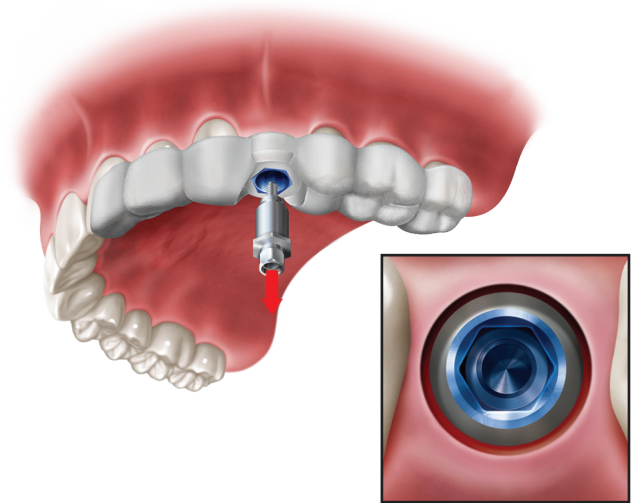

■ Healing Component Placement

Option 1: Healing Abutment

If observing a single-stage surgical protocol, select a Healing Abutment of the appropriate height and diameter. Thread the healing abutment into place atop the implant. Hand-tighten with the appropriate Prosthetic Driver.



Single-Stage Surgical Protocol

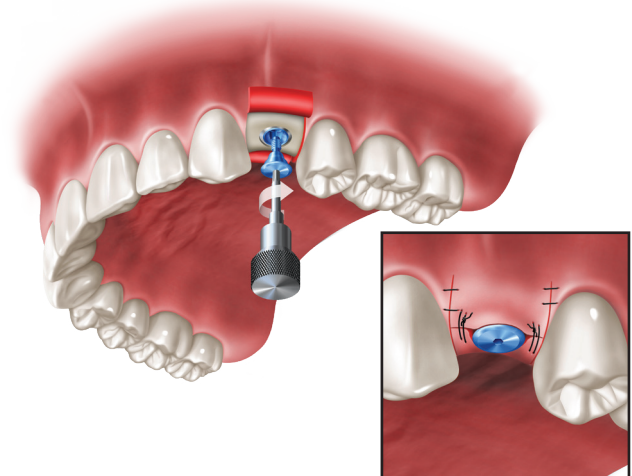

Option 2: Cover Screw

If observing a two-stage surgical protocol, thread the Cover Screw into place atop the implant. Hand-tighten with the appropriate Prosthetic Driver.



Two-Stage Surgical Protocol

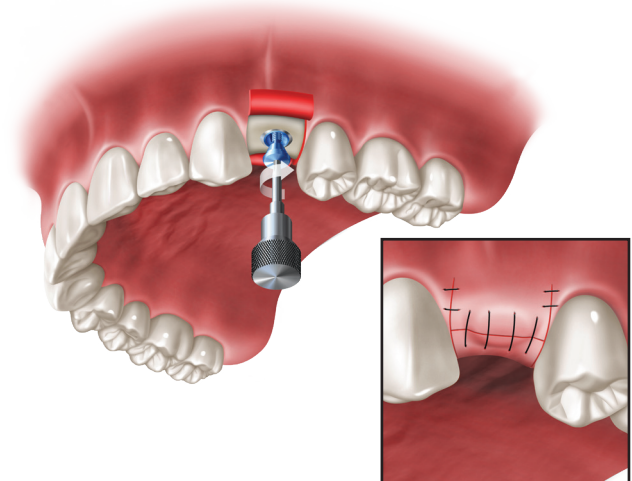

■ Closure and Suturing

If the soft tissue was reflected, close and suture the flap utilizing the desired technique. Take a postoperative radiograph to use as a baseline, and advise the patient as to the recommended postoperative procedures.

■ Second-Stage Uncovery (Two-Stage Surgical Protocol)

Following the appropriate healing period, make a small incision in the gingiva over the implant site to expose the Cover Screw. Using the Prosthetic Driver, remove the Cover Screw and place a healing abutment or temporary abutment of the appropriate height and diameter.

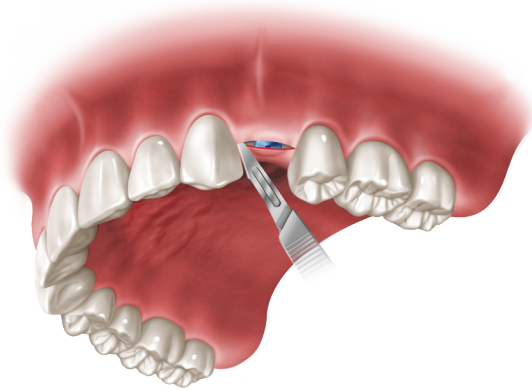

Step 1: Expose the Cover Screw

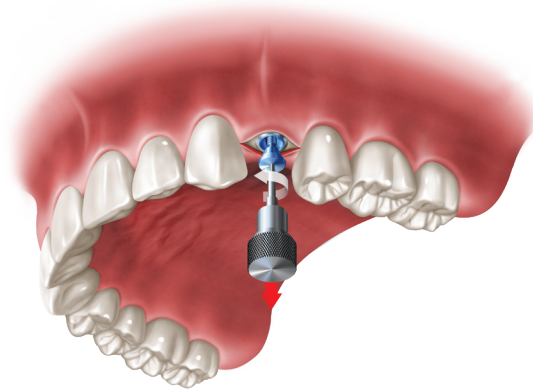

Step 2: Remove the Cover Screw

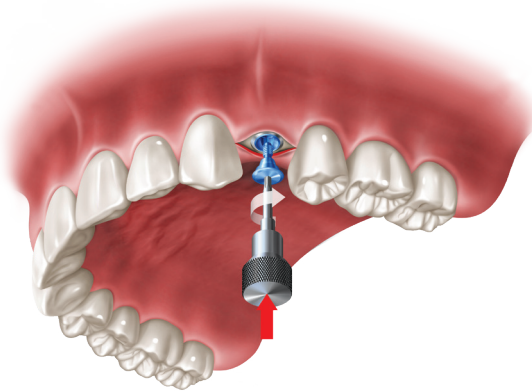

Step 3: Place Healing Abutment

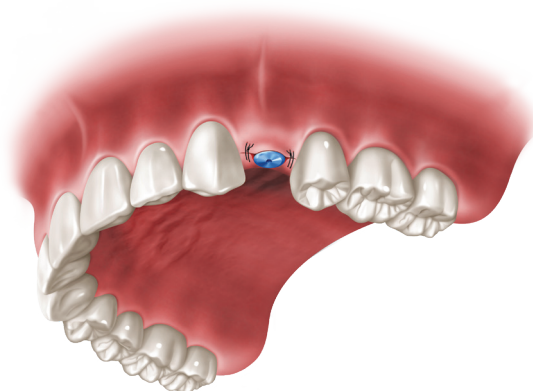

Step 4: Close and suture

GUIDED DRILLING SEQUENCES



Glidewell HT™ Implant Ø3.0 mm

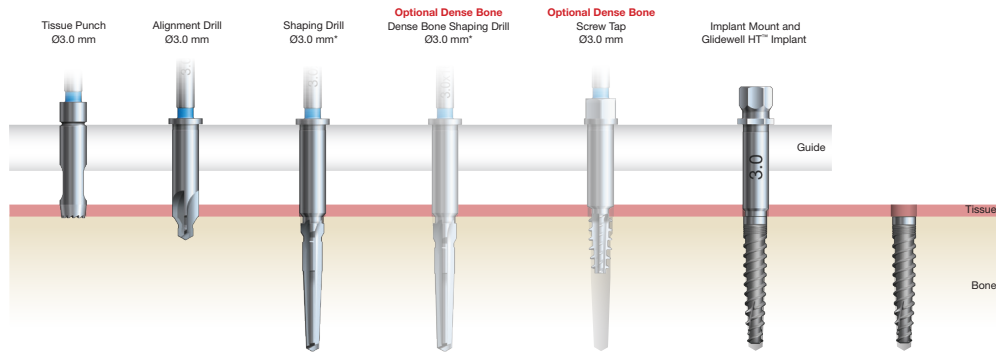

Glidewell HT™ Implant Ø3.5 mm

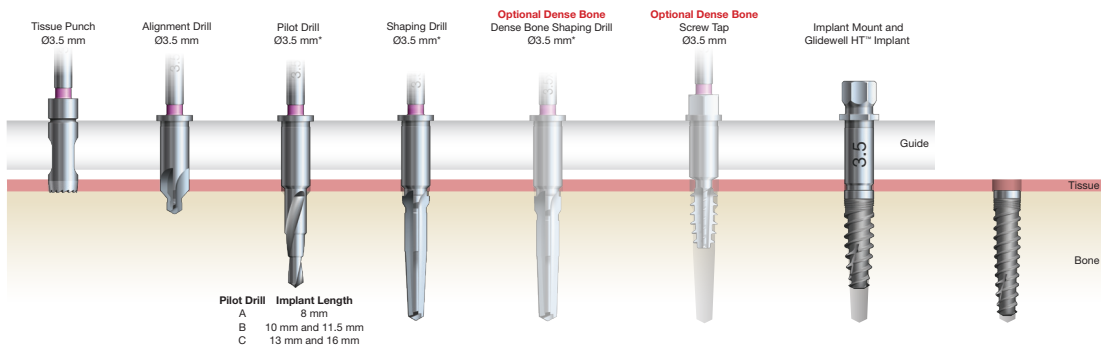

Glidewell HT™ Implant Ø4.3 mm

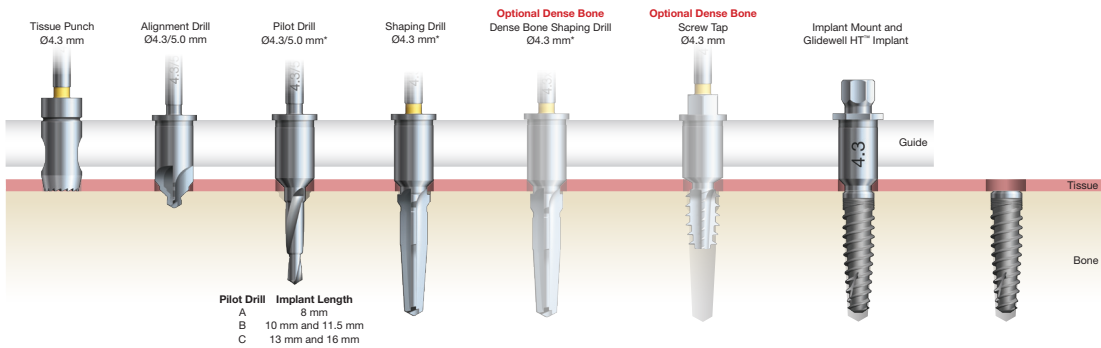

Glidewell HT™ Implant Ø5.0 mm

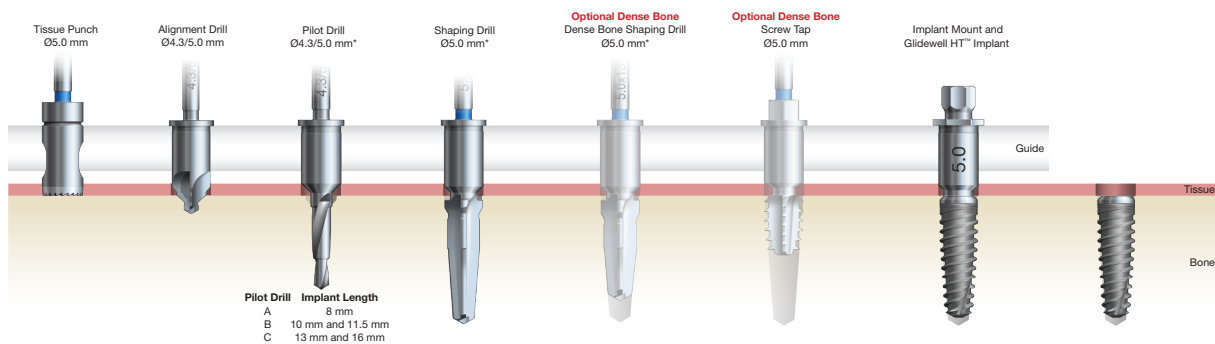

Ensure all surgical instruments are available prior to surgery. Do not use any drill that exceeds the diameter or length of the prescribed implant.

*Available in various lengths.

IMPLANT PACKAGING

Glidewell HT™ Implants are shipped sterile. They should not be resterilized. They are for single use only, prior to the expiration date. Do not use implants if the packaging has been compromised or previously opened. Do not handle implant surfaces directly. Users are advised to visually inspect packaging to ensure seals and contents are intact prior to use. Please refer to the individual product label for all relevant product information and cautions.

IMPLANT PACKAGING

Explanation of Label Codes:

1. Official product description
2. Date of Manufacture (YYYY-MM-DD)
3. Catalog Number
4. Lot/Batch Number
5. By Prescription Only
6. Do Not Use if Package is Damaged
7. Sterile with Gamma Radiation
8. Use-by Date
9. Consult Instructions for Use
10. Do not Re-use
11. Do not Resterilize
12. Manufacturer
13. Country of origin
14. Unique Device Identification (UDI)
15. QR code for IFU website



Ø3.0 x 11.5 mm

1 Glidewell HT™ Implant
Ø3.0 x 11.5 mm

7 STERILE R

8 Use by
YYYY-MM-DD

11

9

<https://ifu.glidewelldental.com>
IFU CODE: IFU-012631
tel: (888) 402-1725

6

10

12 Prismatic Dentalcraft, Inc.
2144 Michelson Drive
Irvine, CA 92612, USA

5 Rx only

13

14

15

2 YYYY-MM-DD

3

4 **LOT** 1234567

1 pc.

15 LBL-012624_1

REF 70-1189-IMP001

***D745701189IMP00010/\$\$3YYMMDD1234567/16DYYYMMDDR**

Ø3.0 x 11.5 mm

POLICIES AND WARRANTY

Ordering Information

Order at glidewelldirect.com or call Glidewell Direct at 888-303-3975. Our product specialists are committed to answering questions in a timely fashion to ensure your ordering is easy and efficient. We are available Monday–Friday from 6:00 a.m.–5:00 p.m. (PST).

Shipping Policy

- Orders placed after 3 p.m. (PST) will be processed on the following business day. Business days do not include Saturdays, Sundays, or U.S. holidays.
- Online shopping cart available to U.S. customers only.

Terms

All accounts are payable within 30 days of invoice date. Accounts not paid within the stated terms will be subject to COD status and a late charge of 2 percent of the unpaid balance. We accept American Express, Visa, MasterCard, and Discover. All prices are subject to change without notice.

Product Return Policy

Products may be returned at the customer's expense for credit within 30 days of invoice date. All returned products must meet the following conditions:

- A copy of the original invoice must accompany the products.
- Products must be packaged to arrive at the seller's facility undamaged.
- Discontinued, obsolete, expired, damaged, or opened items will not be accepted for return.
- Amount credited will be based on invoice price, less 15 percent for restocking fee.
- Shipping charges are the responsibility of the customer and will not be credited.

Product & Pricing Changes

Because products and equipment are continually undergoing refinement in design and manufacturing methods, we reserve the right to improve, modify, or discontinue products and equipment or change pricing at any time without incurring any obligation and without prior notice.

Warranty

Limited Warranty—Prismatik Dentalcraft, Inc.

Prismatik Dentalcraft, Inc. ("Prismatik"), is the manufacturer of dental products (the "product"), including Glidewell HT™ Implants ("implants"). Prismatik and Glidewell Direct hereinafter are referred to collectively as Glidewell. Prismatik warrants the Glidewell HT Implant for the life of the patient originally receiving the implant from the date of placement, and for a period of six (6) months for ceramic blanks and any other product ("the warranty period"). Glidewell will at its option replace or refund the purchase price of any product, to the original purchaser ("user"), that is returned due to defects in material and manufacture.

NO GUARANTEE OR WARRANTY IS IMPLIED OTHER THAN EXPRESSLY STATED, INCLUDING ANY IMPLIED WARRANTY OF MERCHANTABILITY OR FITNESS FOR A PARTICULAR PURPOSE.

Glidewell shall not be liable for any incidental or consequential damages, whether foreseeable or not, caused by defects in the product or dental devices produced using said product. User is responsible for determining the suitability of the product for user's application. If this product is defective within the warranty period, user's exclusive remedy and Glidewell's sole obligation shall be replacement or refund of the purchase price of the product. For replacement or refund under this warranty, the original purchaser shall send the product at its own expense, postage prepaid, to Glidewell Direct, 18651 Von Karman Ave, Irvine, CA 92612.



Glidewell HT™

IMPLANT SYSTEM



Official implant of the



Designed & Manufactured in the U.S.A.

by



PRISMATIK
DENTALCRAFT, INC.

2144 Michelson Drive • Irvine, CA 92612, USA

To Order Call:

888-303-3975

Online:

glidewell-ht.com